



# PS08

**Sistema scorrevole  
con binari invisibili**

Sliding system with  
invisible rails





# PS08

**Sistema scorrevole con binari invisibili**  
Sliding system with invisible rails

**Accessori complementari**  
Additional accessories

- **PR20 - Ante in alluminio.**  
PR20 - Aluminium doors
- **BR - Raddrizza ante.**  
BR - Doors Straightener.

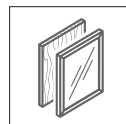
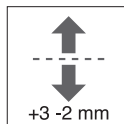
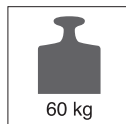
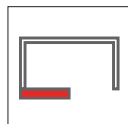
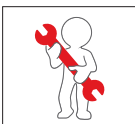



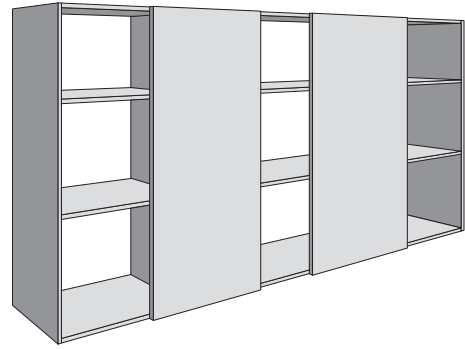
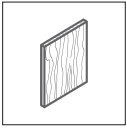

1

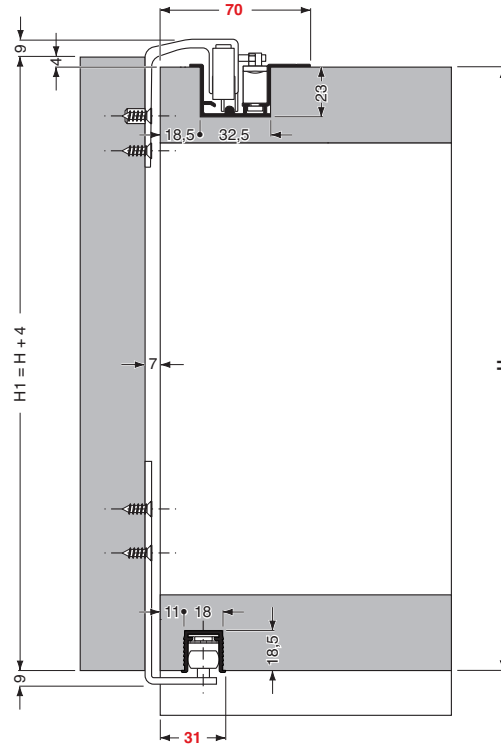

**ABBREVIAZIONI:**  
**S** = sormonto sul fianco  
**ABBREVIATIONS:**  
**S** = overlap on the side panel

2

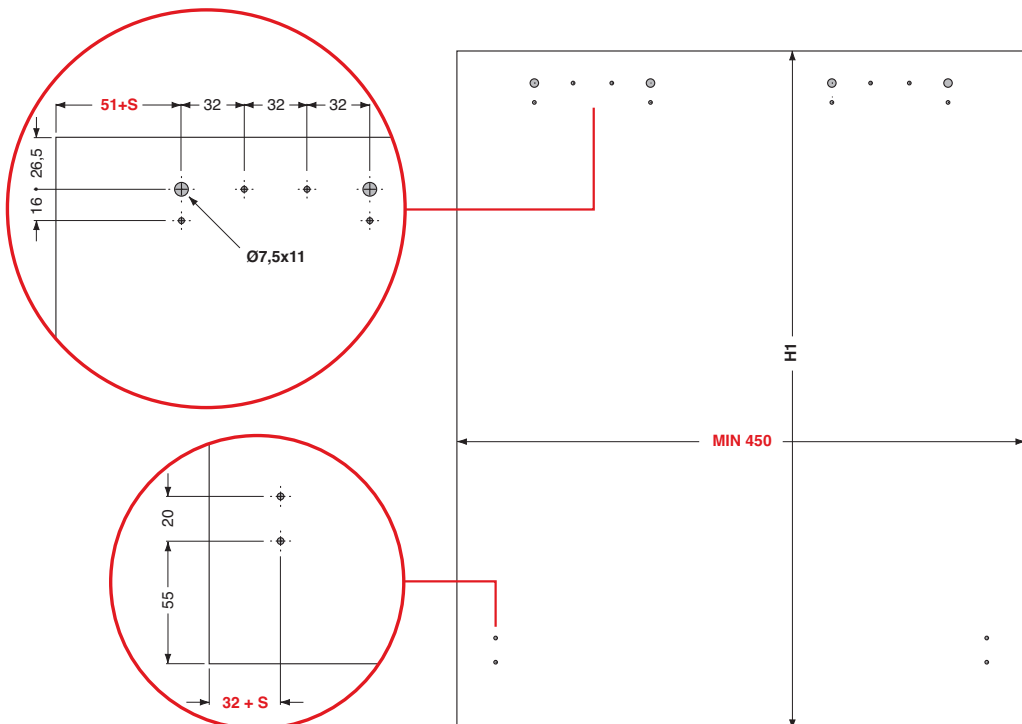



**SOFT**  
closing

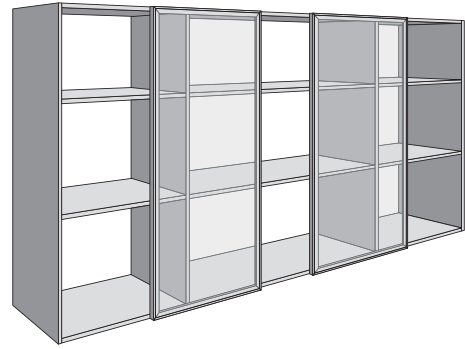

3

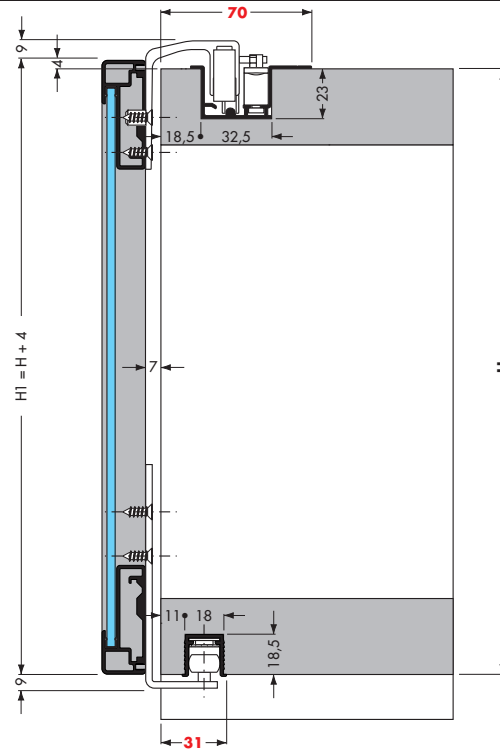

**ABBREVIAZIONI:**  
S = sormonto sul fianco

**ABBREVIATIONS:**  
S = overlap on the side panel

4

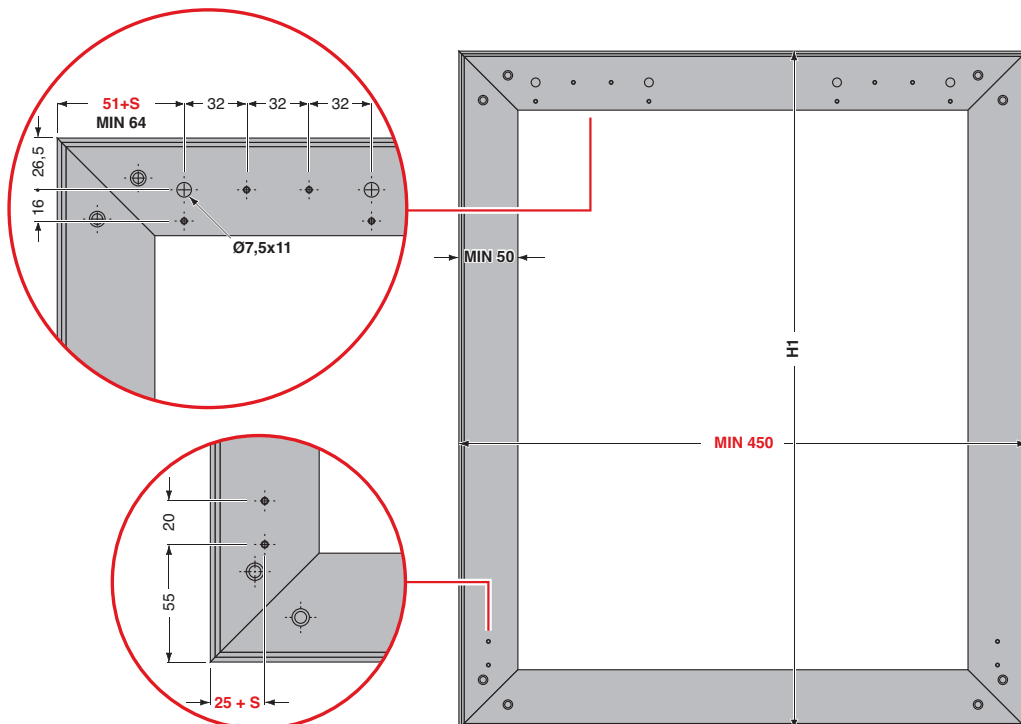

# Lista componenti / Parts list

## PR08700002A

Binario superiore.

Upper rail.

**Finiture standard / standard finishes**

Anodizzato / anodized: Silver

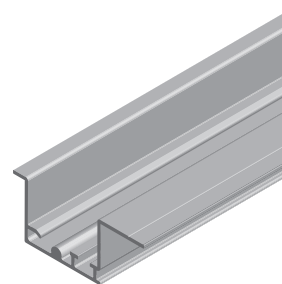
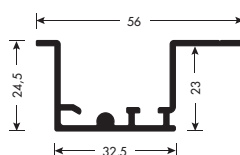

## PR07700006A

Binario inferiore.

Lower rail.

**Finiture standard / standard finishes**

Anodizzato / anodized: Silver

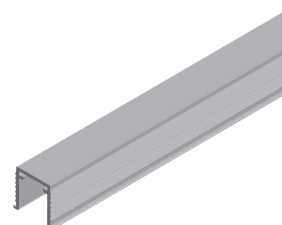
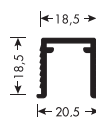

## PS08AP70020002

Confezione anta.

Finitura: Anodizzato argento chimico

Door kit.

Finish: Chemical silver anodized

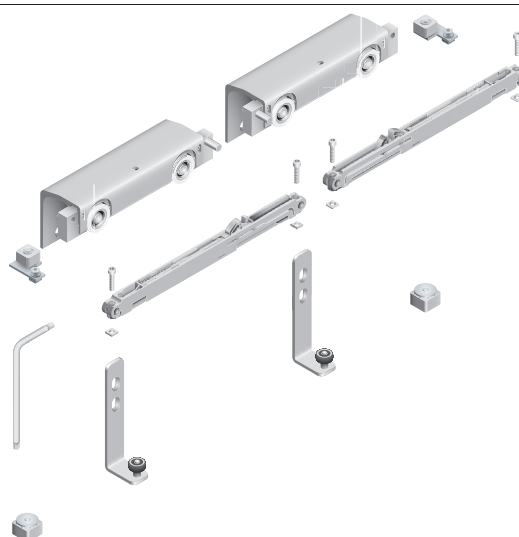

## Accessori complementari

### Additional accessories

#### BR

Raddrizza ante.

Doors straightener.

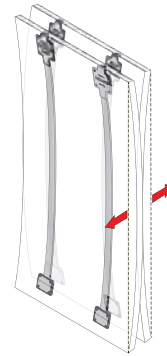

#### PR20

Ante in alluminio.

Aluminium doors.

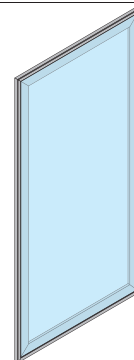

Tutte le parti del catalogo sono di proprietà della Cinetto F.lli S.r.l.

È vietata qualsiasi imitazione e copia delle illustrazioni, della grafica e la riproduzione, anche parziale, del presente catalogo senza autorizzazione.

I disegni tecnici e le informazioni dimensionali, incluse le illustrazioni, riportate in questo catalogo non sono vincolanti. L'azienda si riserva il diritto di apportare modifiche a fini migliorativi. Tutte le dimensioni sono in mm, se non diversamente specificate.

Si declina ogni responsabilità per errori di stampa.

All constituents of the catalogue are the property of Cinetto F.lli S.r.l.

Reprint of the catalogue or extracts thereof, reprinting or imitation of the illustrations or drawings is forbidden without permission.

The technical representations and dimensional information in this catalogue are non-binding, including those in the illustrations and drawings. Right reserved to make design improvements. All dimensions are in mm unless otherwise specified.

No liability accepted for printing errors of the catalogue.

Rilasciato da - Issued by  
Cinetto F.lli S.r.l.  
Via Meucci, 4 - 35030 Rubano (PD) Italy

Tel. +39 049 8977211 - Fax +39 049 635822

Internet: [www.cinetto.it](http://www.cinetto.it) - Email: [info@cinetto.it](mailto:info@cinetto.it)

Ottobre 2021  
© by Cinetto F.lli S.r.l.  
All rights reserved.  
Printed in Padova - Italy



**Sede Legale e Officina di Produzione**

Via Meucci, 4 - 35030 Rubano (PD) Italy

[www.cinetto.it](http://www.cinetto.it) - [info@cinetto.it](mailto:info@cinetto.it)

**Sede Amministrativa, Magazzino e Punto Vendita**

Via Rossi, 5/A - 35030 Rubano (PD) Italy  
Tel. +39 049 8977211 - Fax +39 049 635822  
C.F./P.I. (VAT) (IT) 00277120283

